





ø8x30mm A 40	L=20mm D2 20	ø5/12mm C 20	ø15x5mm F4 6	 E 20	0,05 O11 1
-------------------------------	-------------------------------	-------------------------------	-------------------------------	--------------------	-----------------------------

1.

 $\pm 8 \times 30 \text{ mm}$	 L-20 mm	 $\pm 15 / 12 \text{ mm}$	 0,05
A	D2	C	O11
40	20	20	1

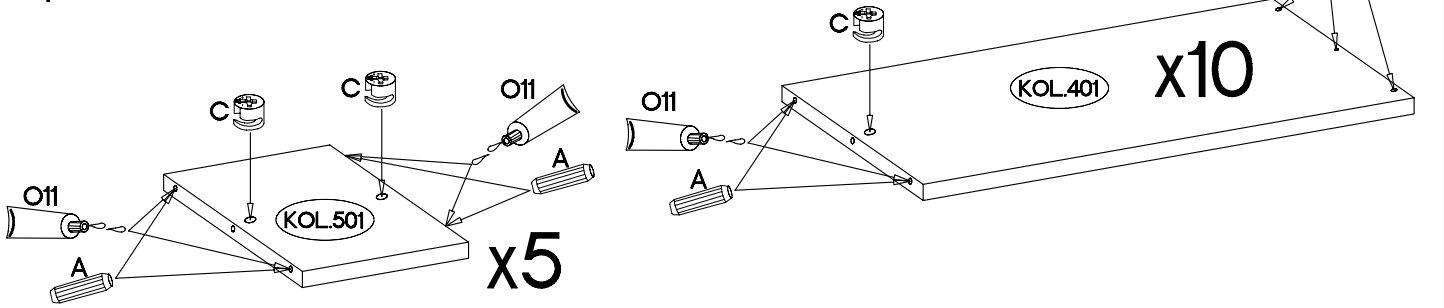
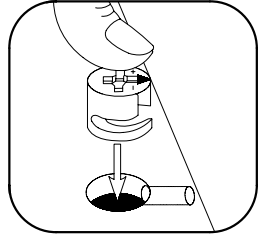
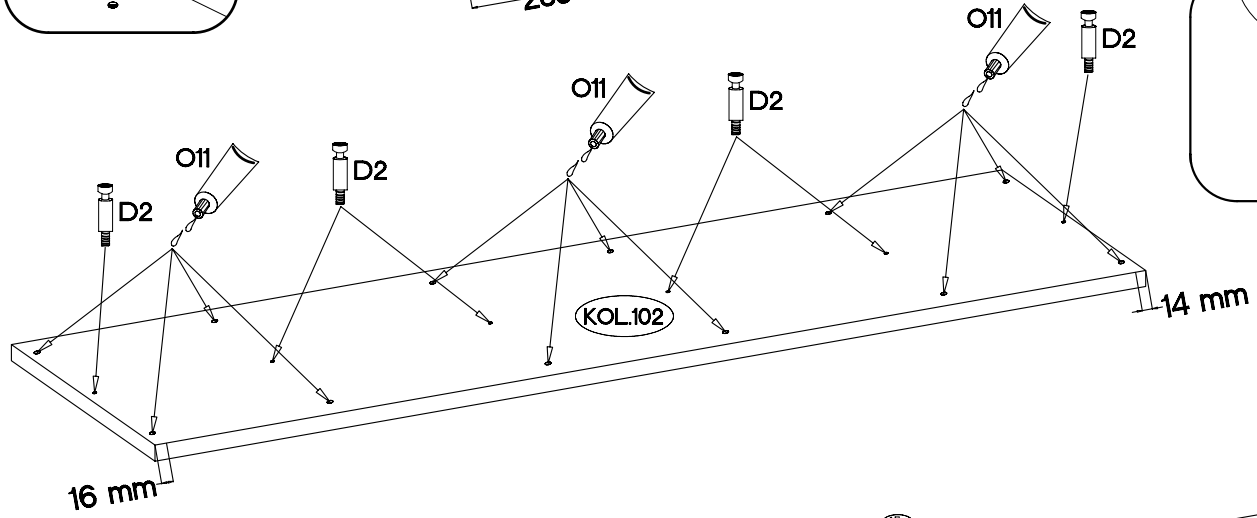
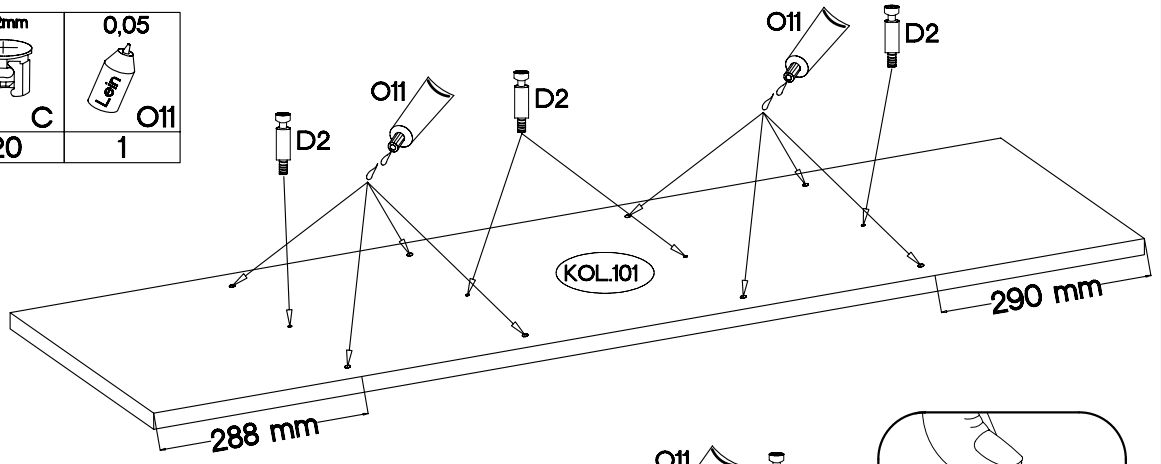
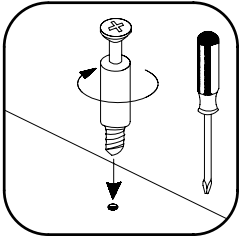

2.

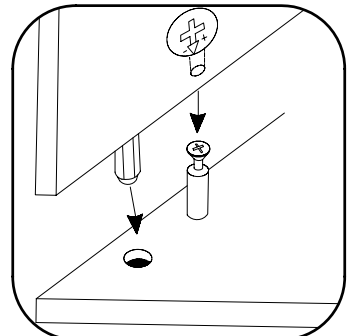
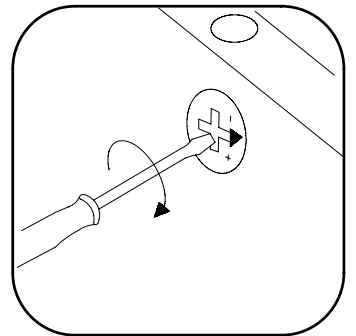
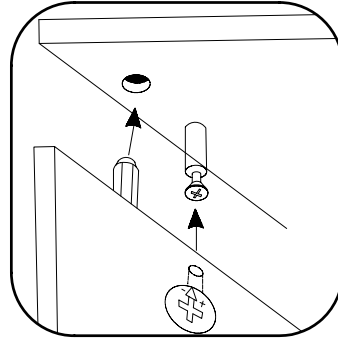
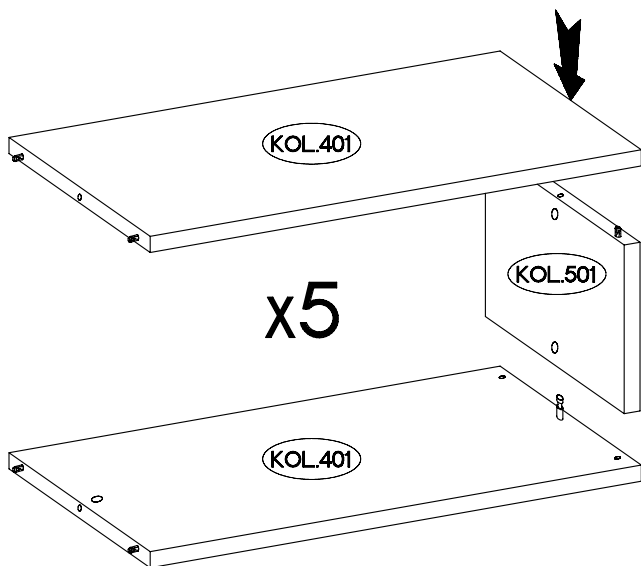

3.

OBRZEŽE

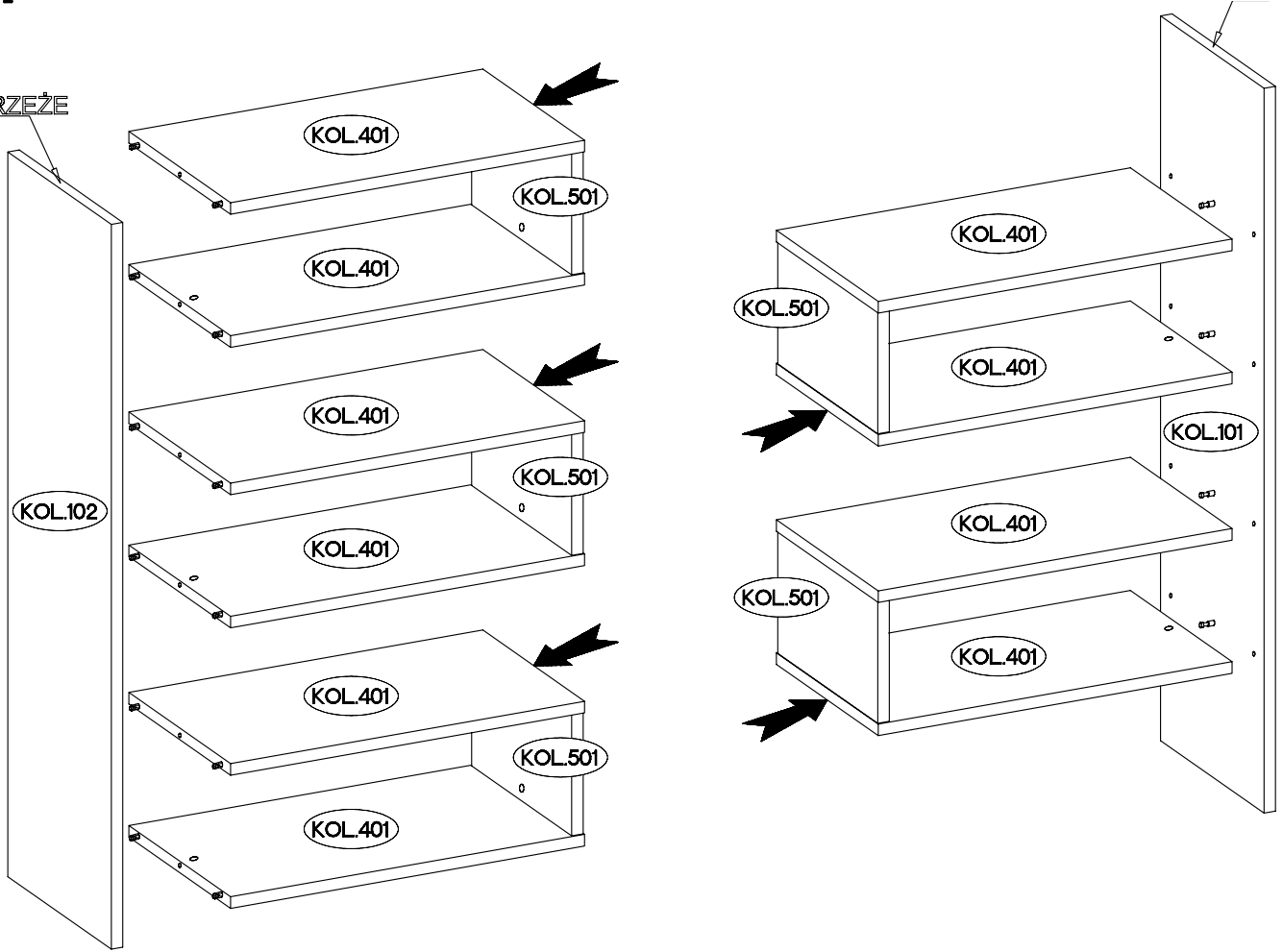

4.

Ø15x5mm	
F4	E
6	20

