

 8x30mm A	 15/12mm C													
8	8													
 L=20mm D2	 20 E11	 14 E13	 L K9	 R K10	 L K11	 R K12	 L	 5 M10	 6,5/68mm O4	 10x50mm O7				
8	8	4	1	1	1	1	6	1	2	2				

MTA.119	329x419x18
MTA.120	329x419x18
MTA.208 x2	799x420x18
MTA.609	338x771x2,5

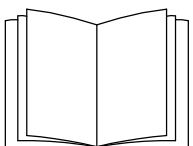

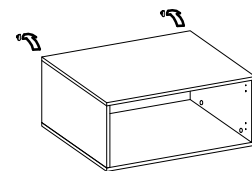
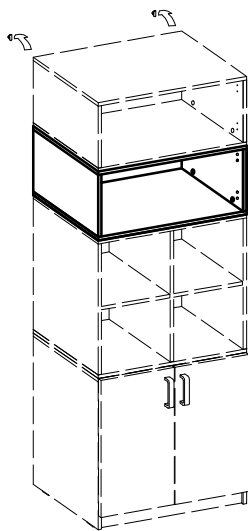
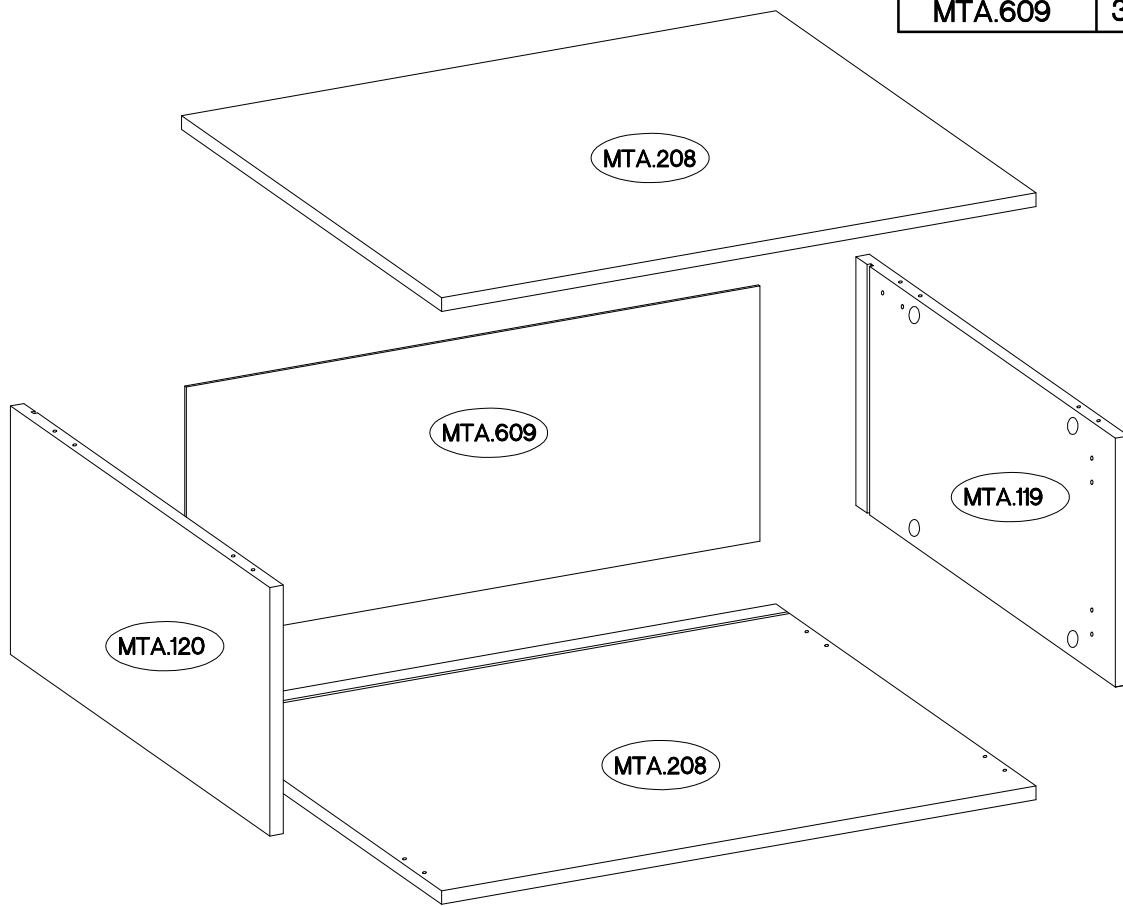
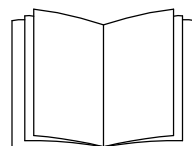

1 — 4



5 — 10

1

$\varnothing 8 \times 30 \text{mm}$ 	L=20mm 	$\varnothing 15/12 \text{mm}$ 
12	D2	C
8	8	8

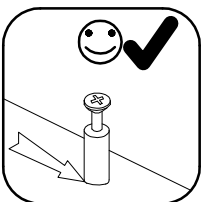
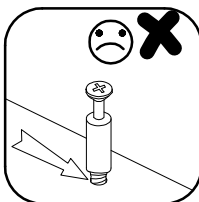
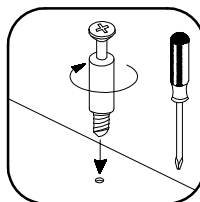
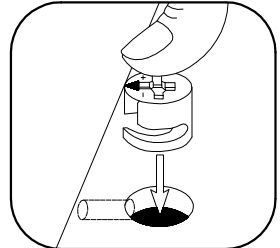
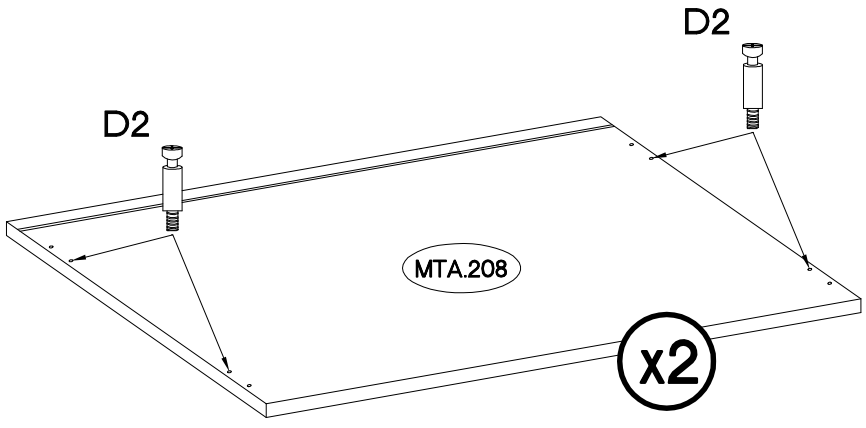
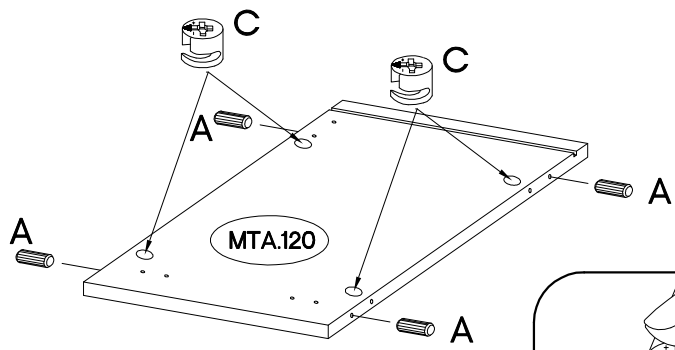
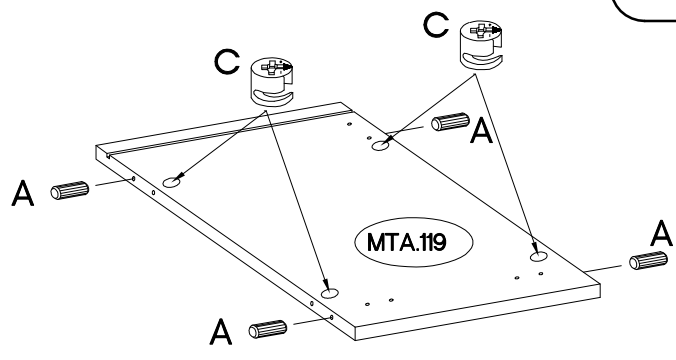
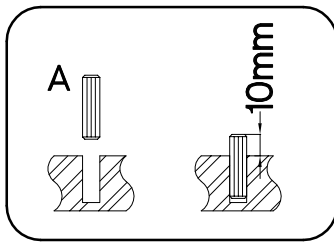
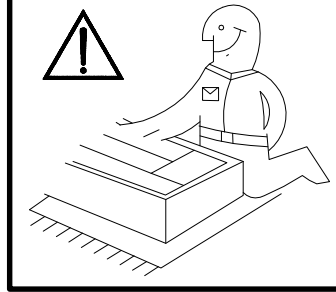

2

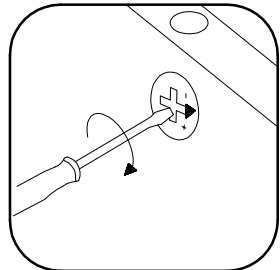
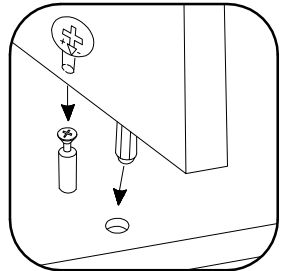
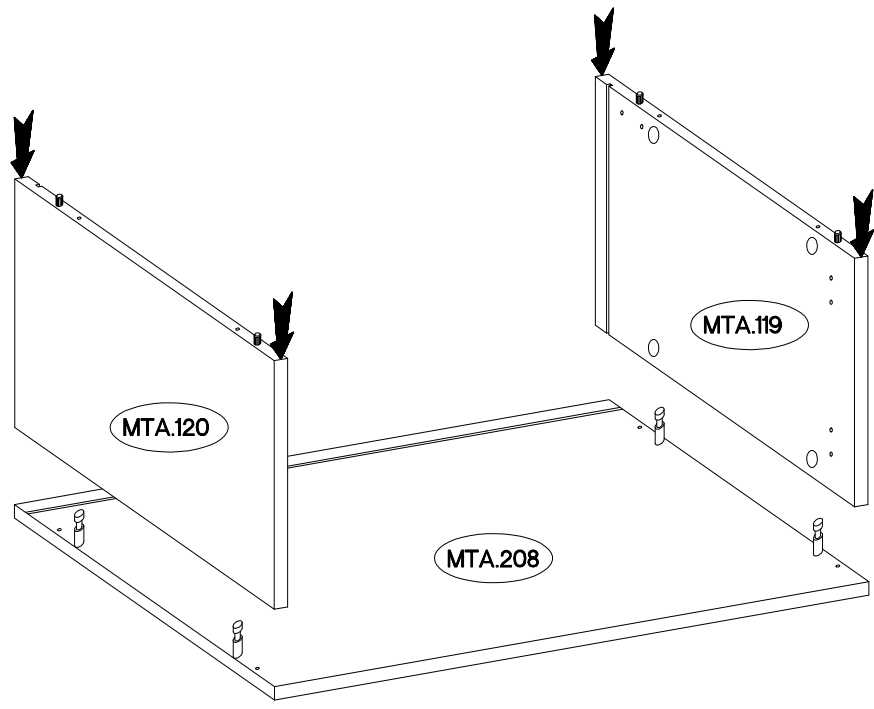



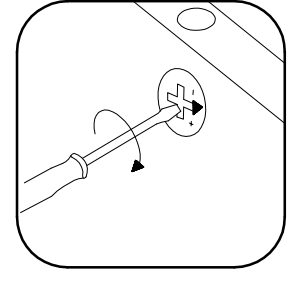
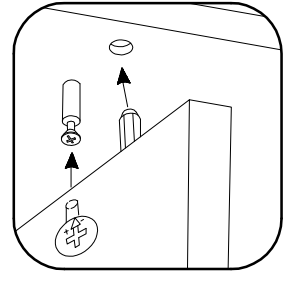
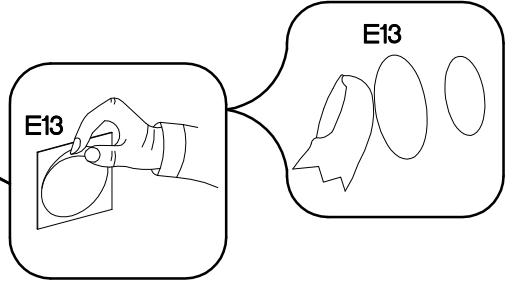
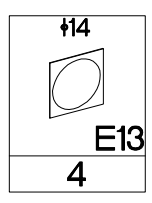
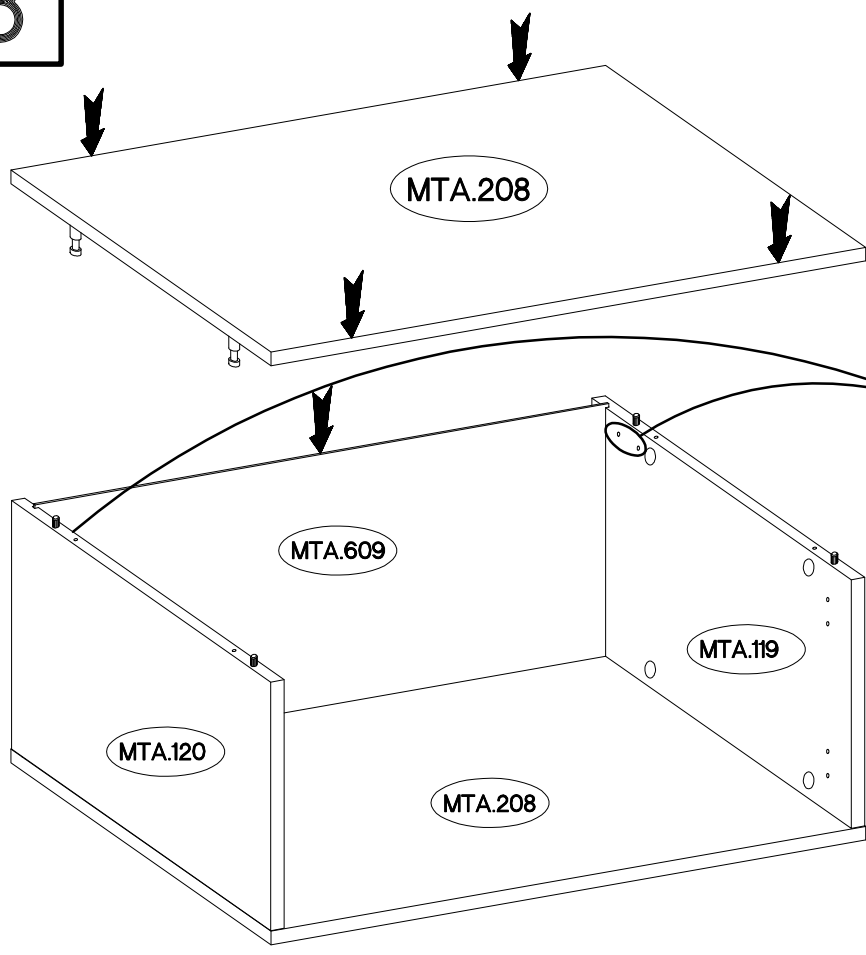

3

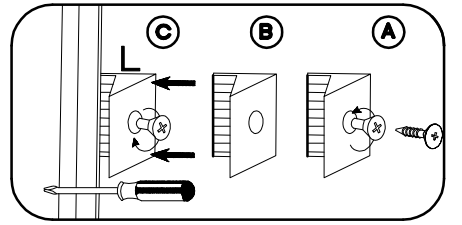
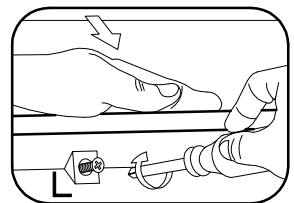
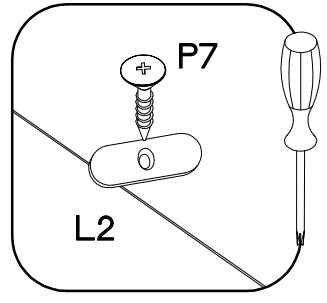
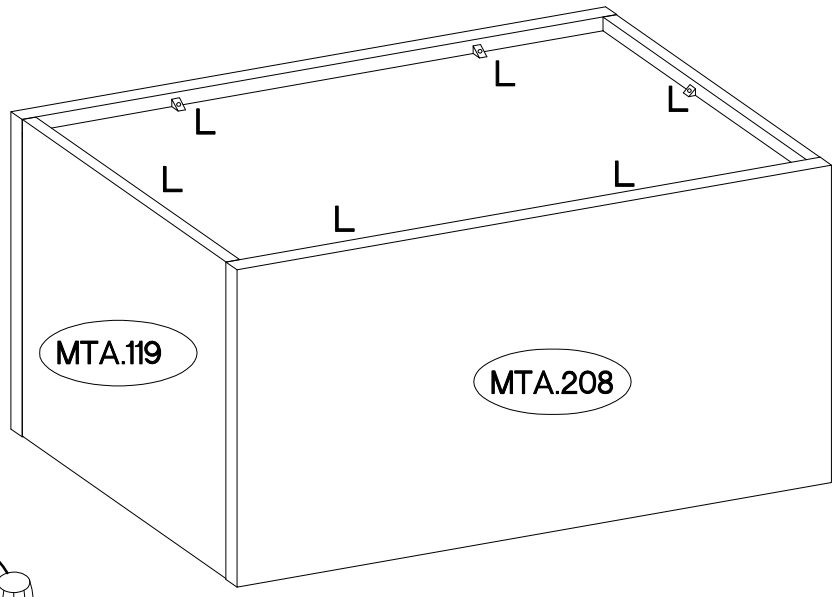
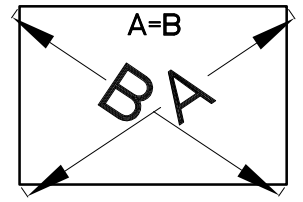
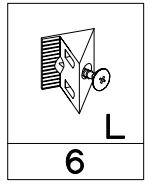

4



5

$\varnothing 8 \times 30 \text{mm}$  12 8	L=20mm  D2 8	$\varnothing 15/12 \text{mm}$  C 8	L  K9 1	R  K10 1
--	---	---	--	---

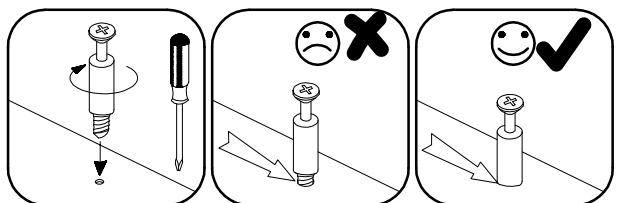
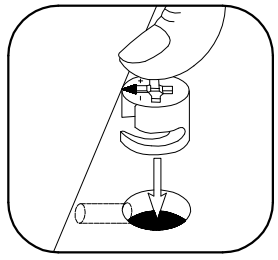
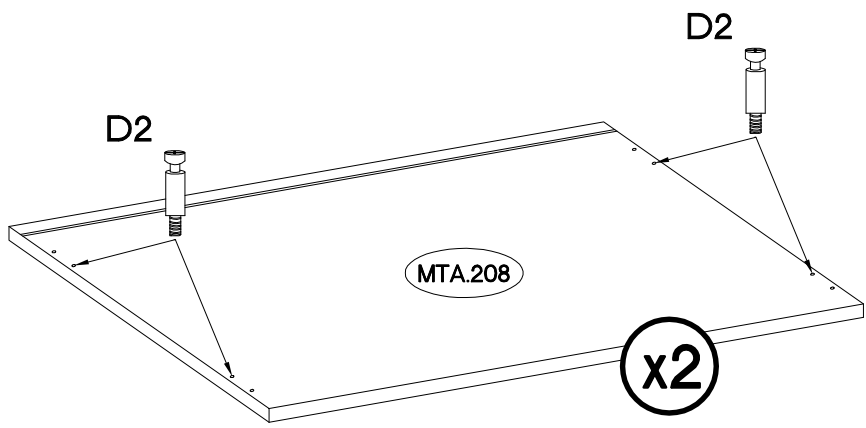
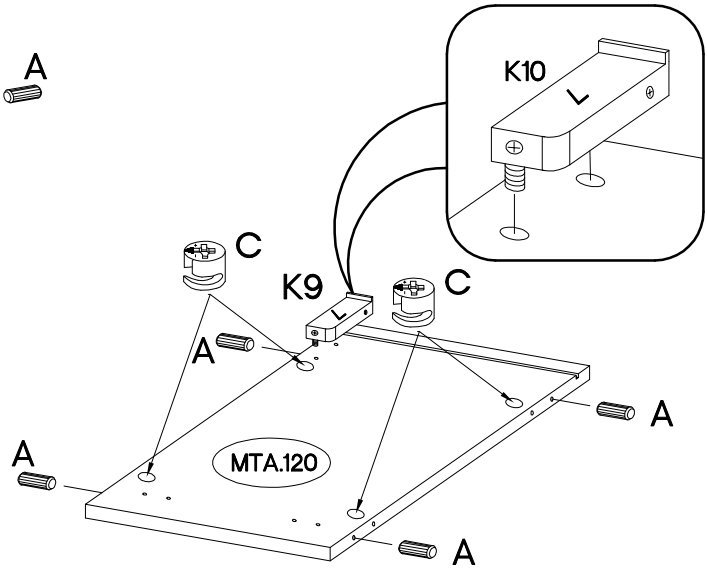
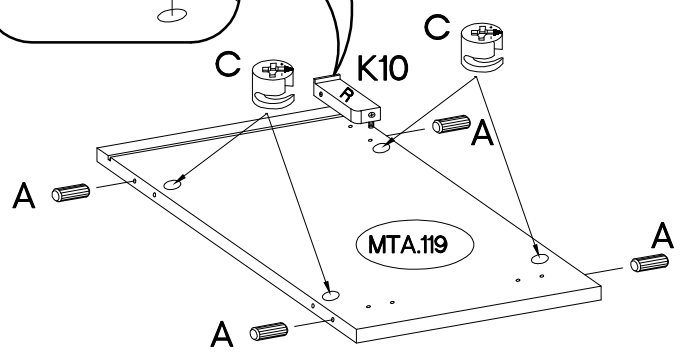
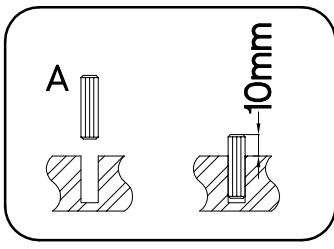
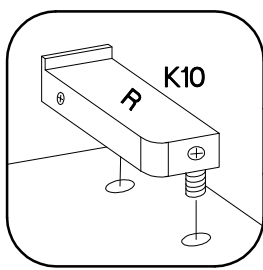
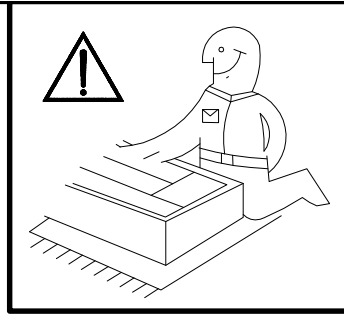

6

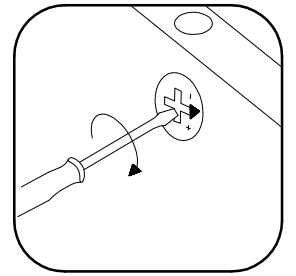
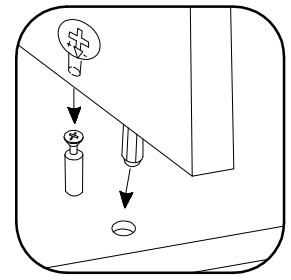
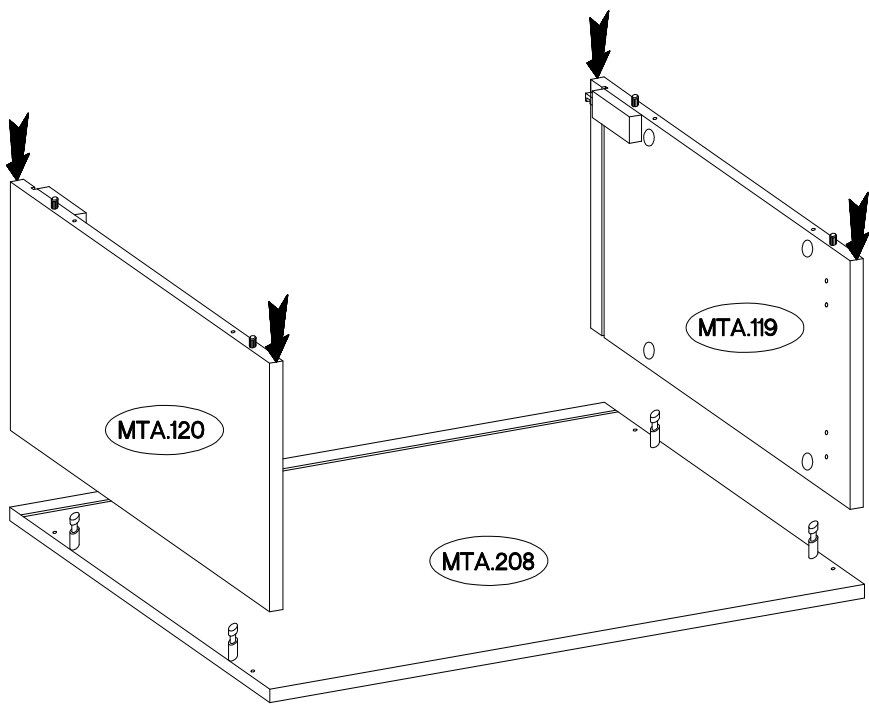

7

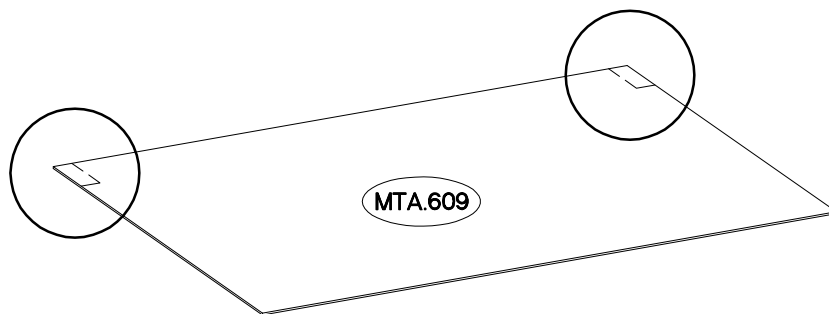
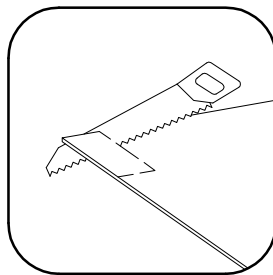
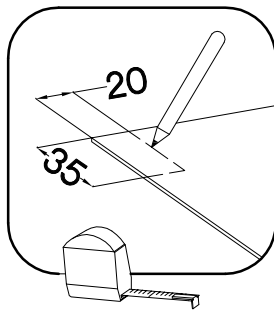



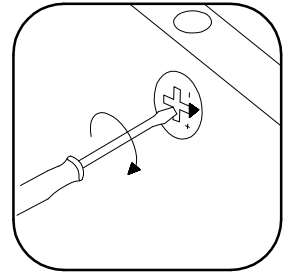
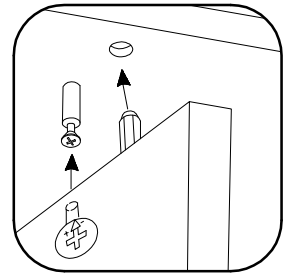
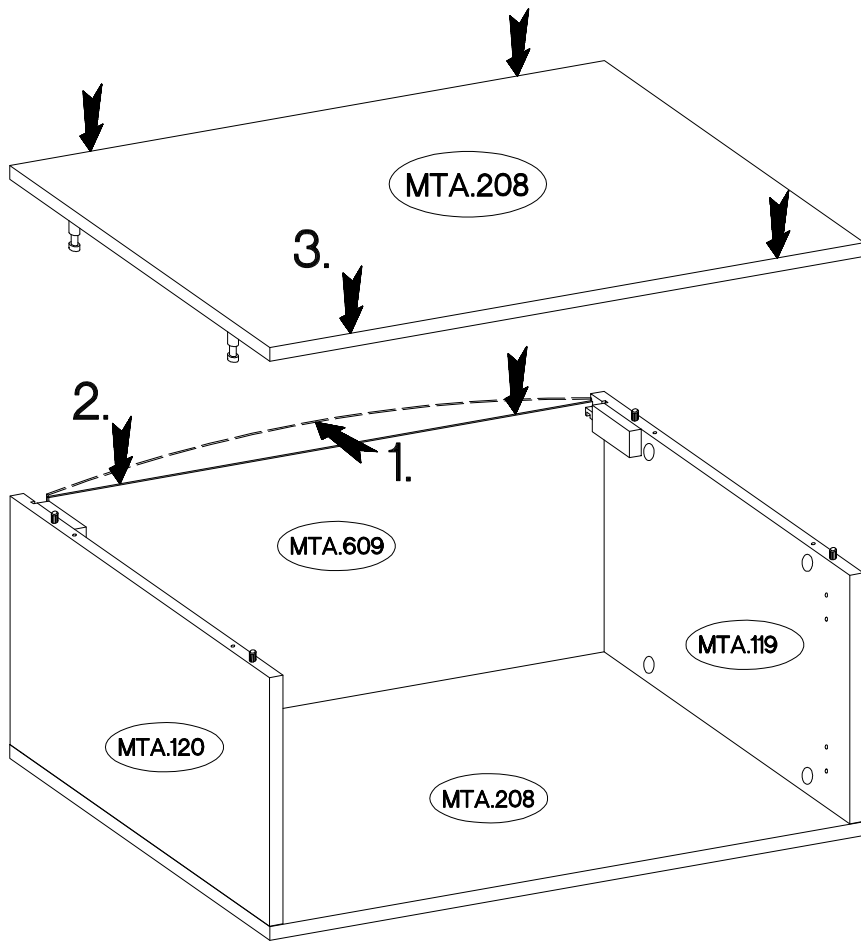

8

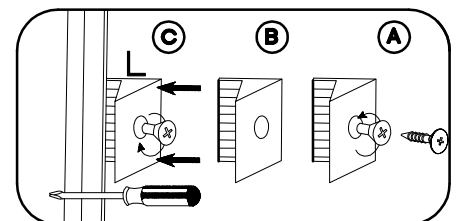
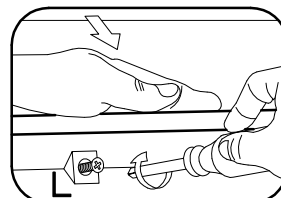
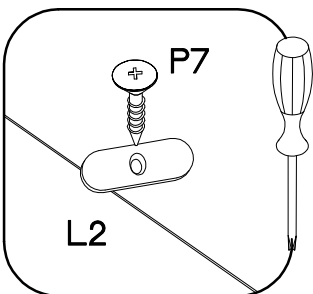
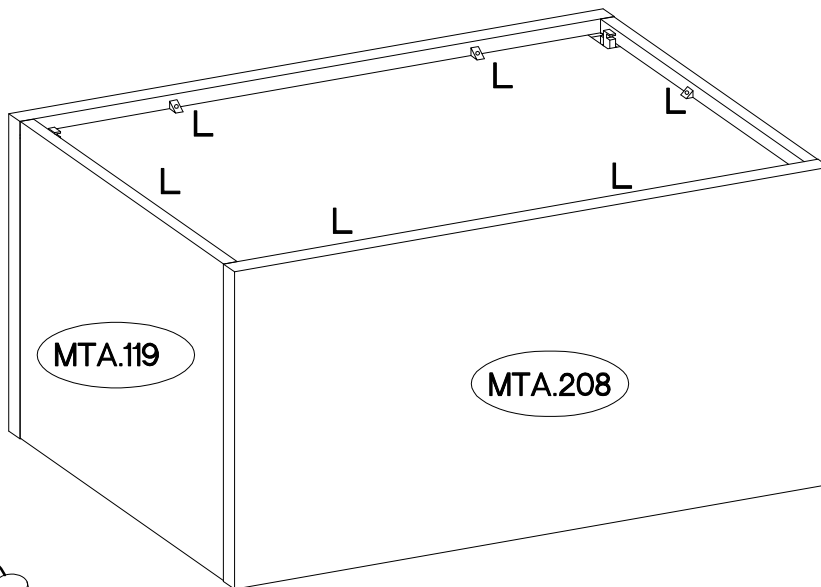
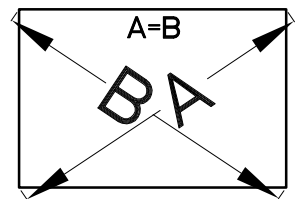
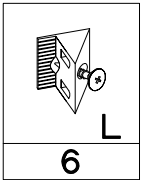

9

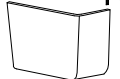

$\varnothing 10 \times 50 \text{mm}$  O7 2	$6,5/68 \text{mm}$  O4 2	L  K11 1	R  K12 1	$\varnothing 20$  E11 8
---	---	---	---	--

