

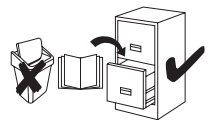

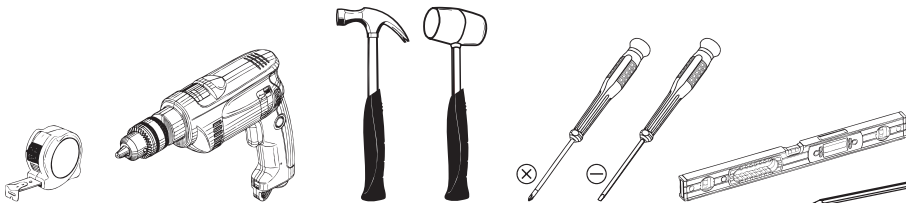

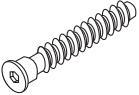





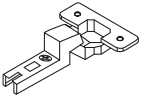
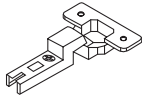
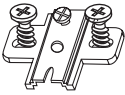
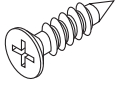



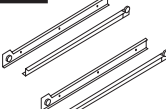

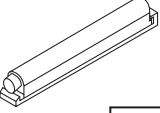
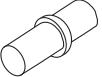

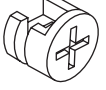
 300

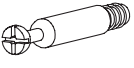

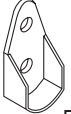
<b>A</b>  7 x 50 mm x 12	<b>B</b>  8 x 32 mm x 52	<b>C2</b>  (Z) x 6	<b>C3</b>  (B) x 4	<b>DT</b>  x 10	<b>E</b>  3,5 x 13 mm x 38
<b>E2</b>  3 x 20 mm x 68	<b>E8</b>  4 x 25 mm x 6	<b>G2</b>  x 10	<b>H1</b>  x 12	<b>K</b>  L=450 mm x 2	<b>M</b>  x 1
<b>O2</b>  x 2	<b>P</b>  x 12	<b>Q2</b>  Ø 20 x 20	<b>R</b>  H=11 mm x 20	<b>T3</b>  5 x 9 mm x 8	<b>U</b>  L=24,3 mm x 20
<b>V</b>  L=478 mm x 2	<b>V7</b>  x 4	<b>W14</b>  x 2	<b>XA</b>  x 1	<b>XG</b>  GLUE x 2	<b>ZR</b>  Ø 15 x 12

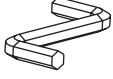

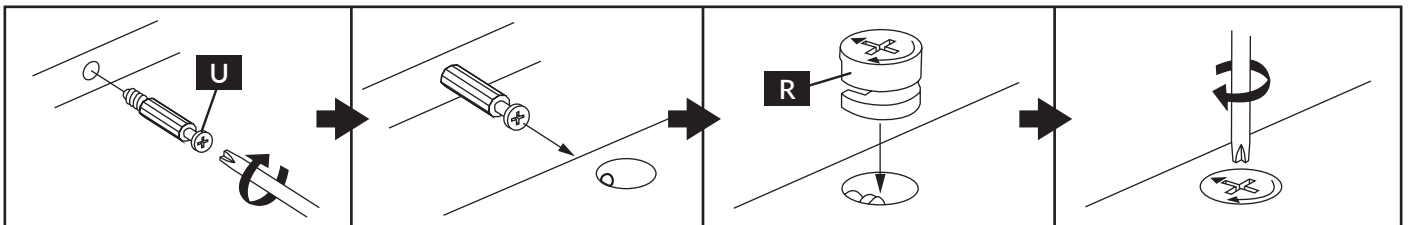
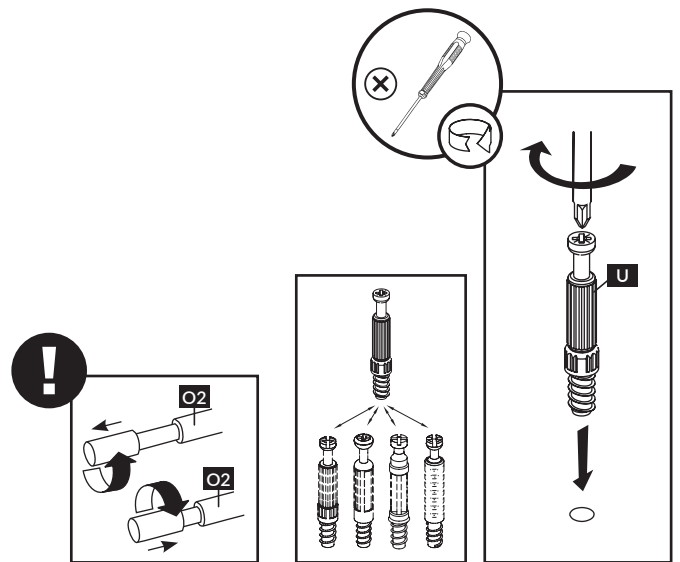
1	A-1	1968 / 80 / 16 mm	x 2
2	A-2	1968 / 535 / 16 mm	x 1
3	A-3	964 / 535 / 16 mm	x 1
4	A-4	964 / 519 / 16 mm	x 3
5	A-5	486 / 524 / 16 mm	x 2
6	A-6	1968 / 570 / 16 mm	x 1
7	A-7	2016 / 570 / 16 mm	x 1
8	A-8	1904 / 535 / 16 mm	x 1
9	A-9	1904 / 535 / 16 mm	x 1
10	A-10	2016 / 570 / 16 mm	x 1
11	A-11	488 / 1511 / 16 mm	x 2
12	A-12	488 / 1917 / 16 mm	x 1

13	A-13	1550 / 65 / 17 mm	x 1
14	A-14	488 / 1917 / 16 mm	x 1
15	A-15	1550 / 65 / 17 mm	x 1
16	A-16	1927 / 500 / 3 mm	x 2
17	A-17	1927 / 980 / 3 mm	x 1
18	A-18	980 / 200 / 16 mm	x 2
19	A-19	907 / 120 / 16 mm	x 2
20	A-20	450 / 120 / 16 mm	x 2
21	A-21	450 / 120 / 16 mm	x 2
22	A-22	937 / 456 / 3 mm	x 2

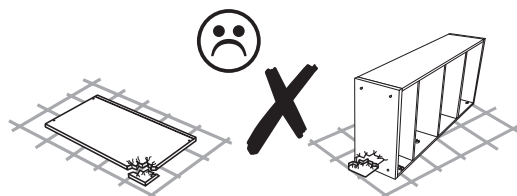
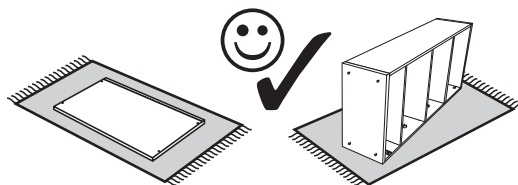
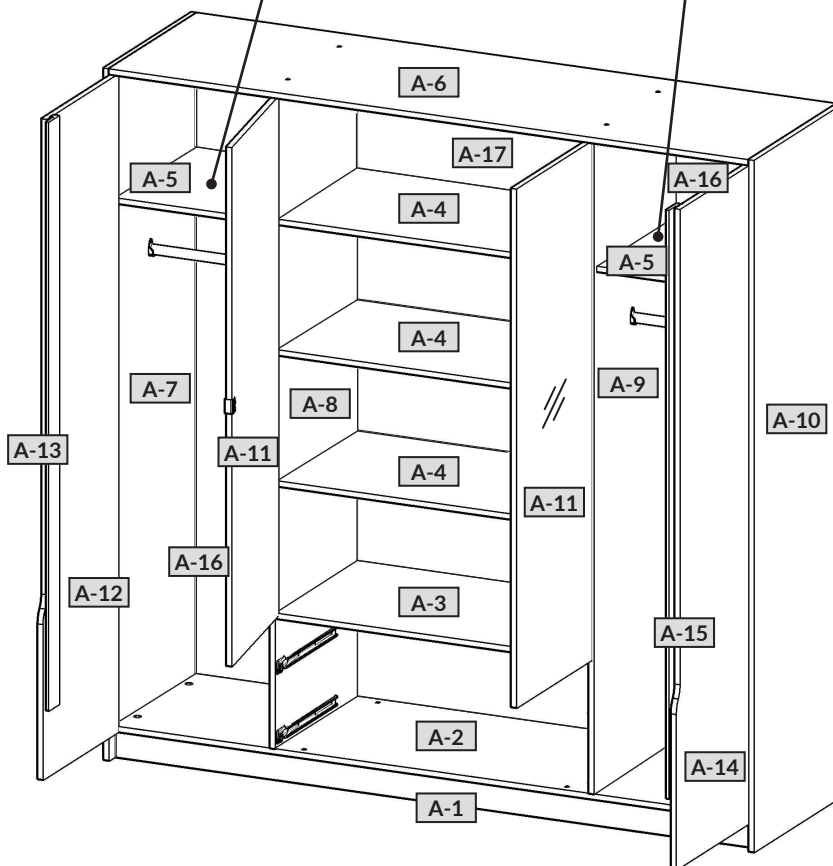
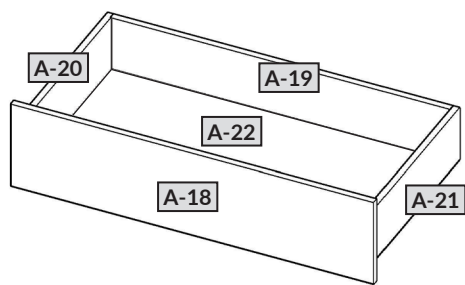
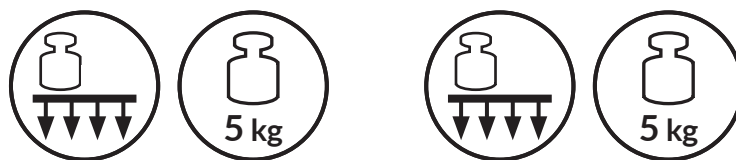
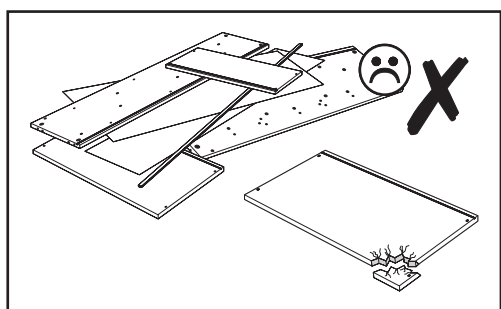

# A / 1

B	x 16
G2	x 6
R	x 8

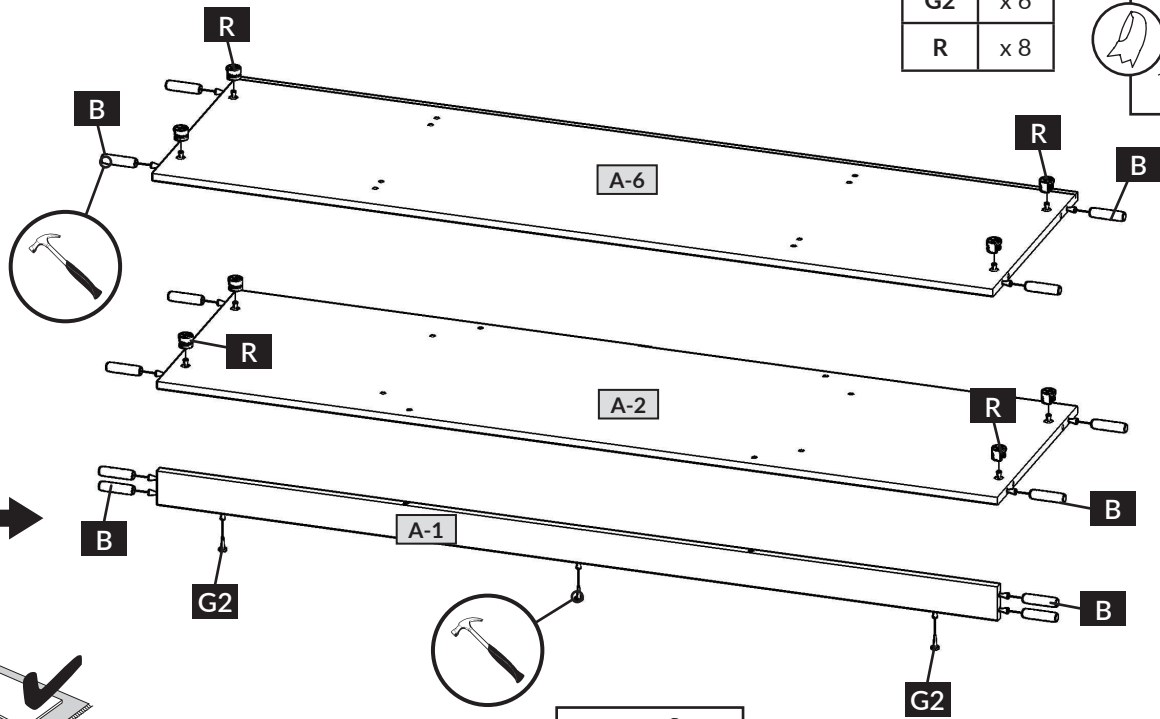
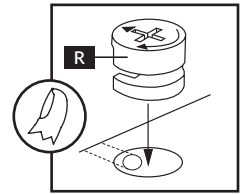

2x →

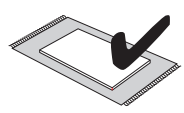

# A / 2

A	x 4
E	x 2
O2	x 1
XA	x 1

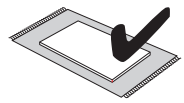
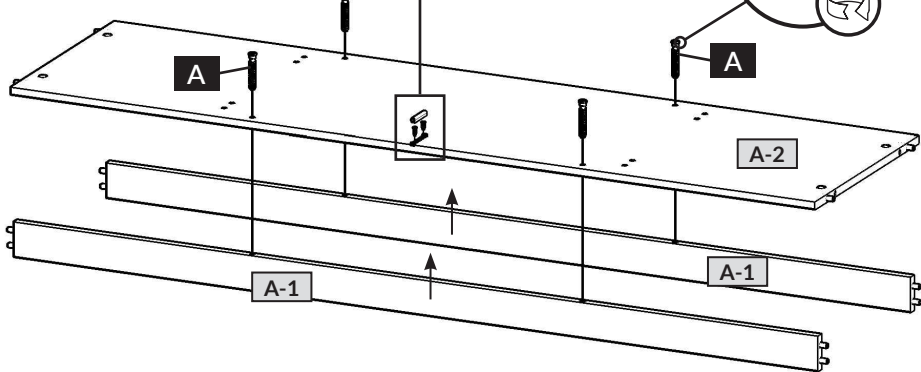
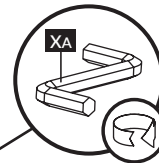
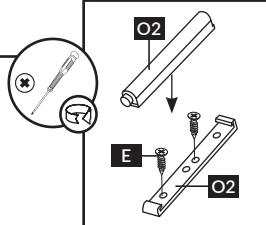

# A / 3

B	x 12
E	x 2
O2	x 1
R	x 12

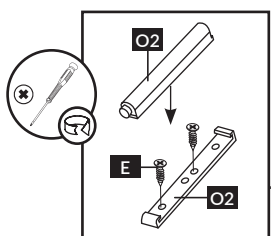

2x →

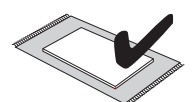
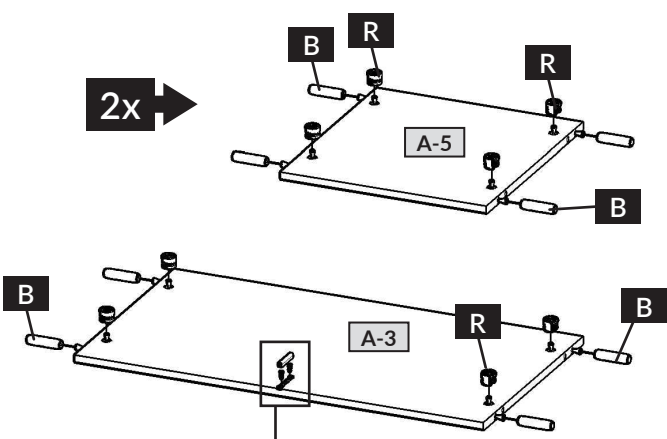
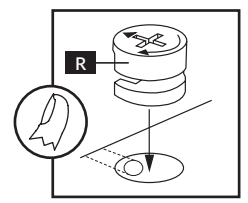

# A / 4

B	x 8
E	x 4
U	x 4
V7	x 2

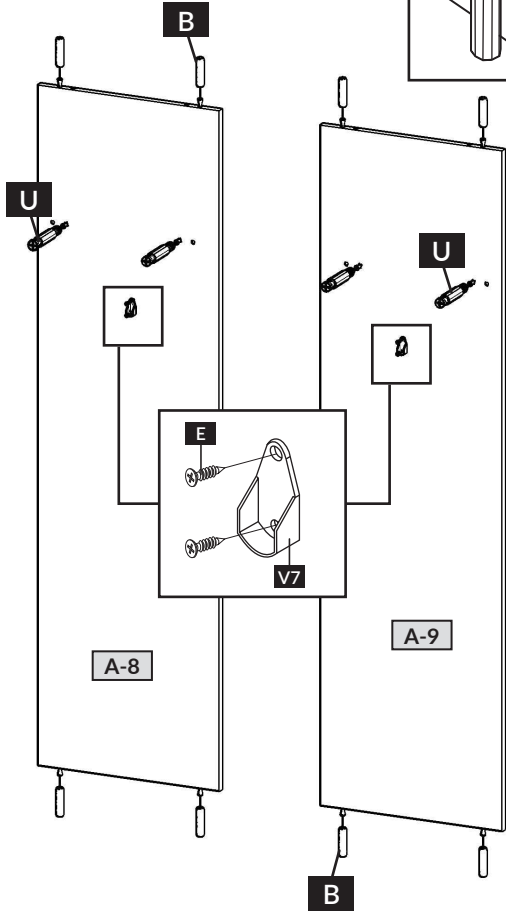
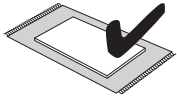
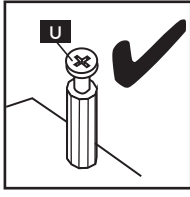
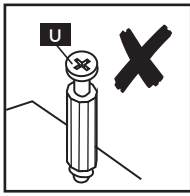

# A / 5

DT	x 4
K	x 2
P	x 12
T3	x 8
U	x 4

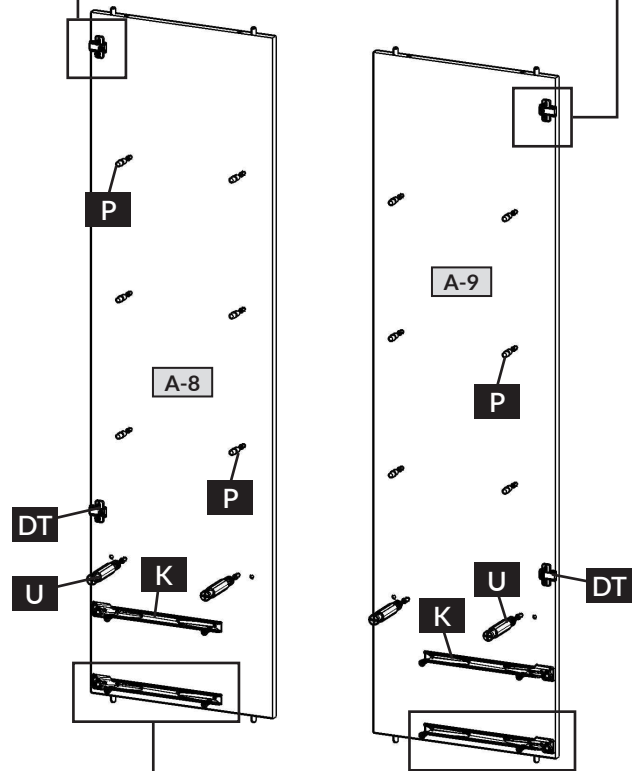
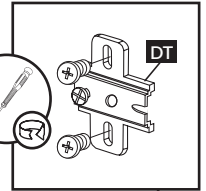
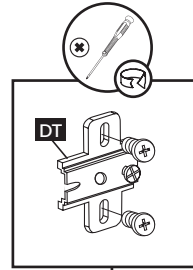
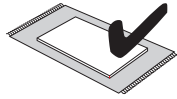
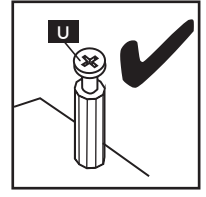
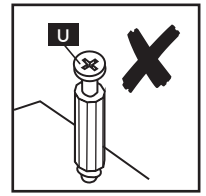

# A / 6

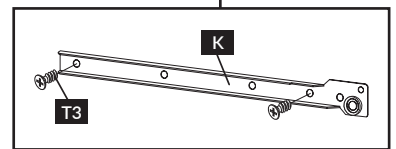
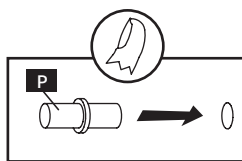
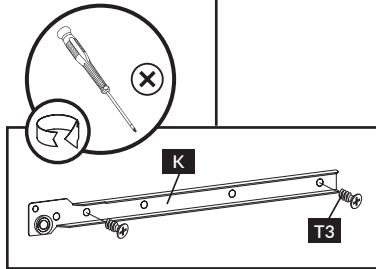
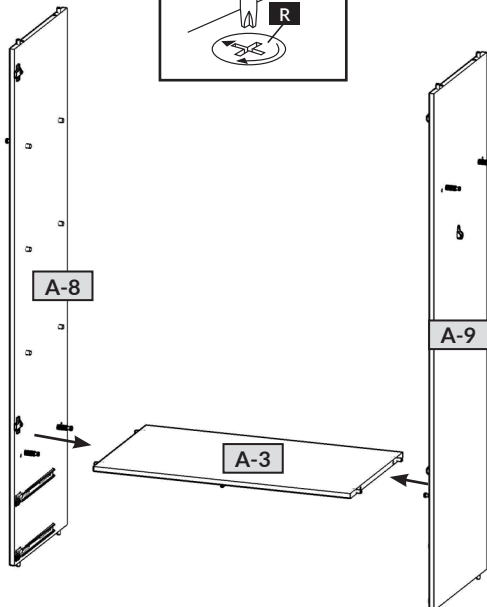
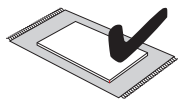
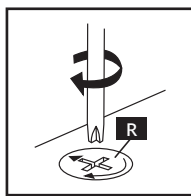

**A/7**

A	x 4
XA	x 1

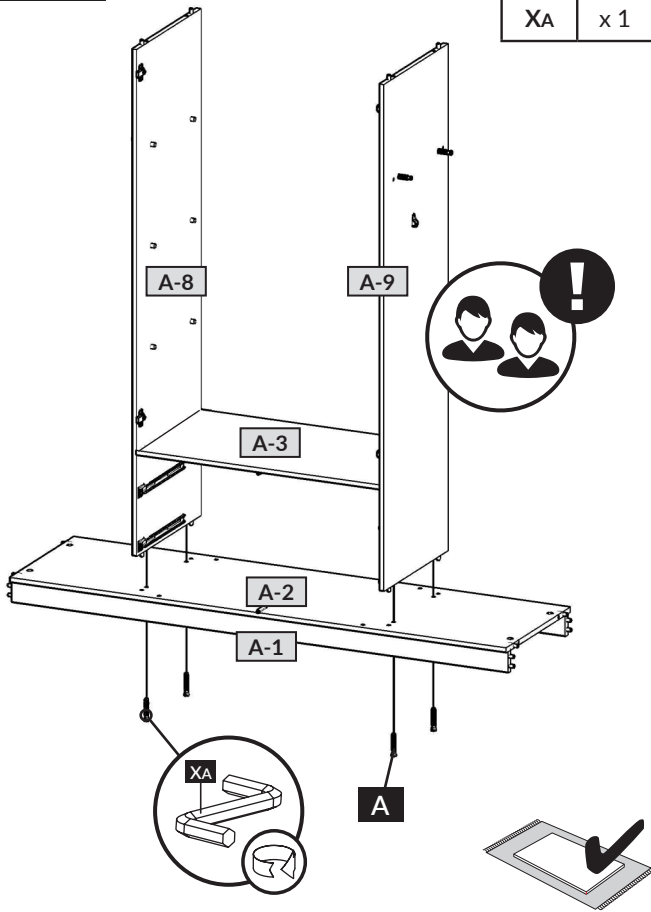

**A/8**

A	x 4
XA	x 1

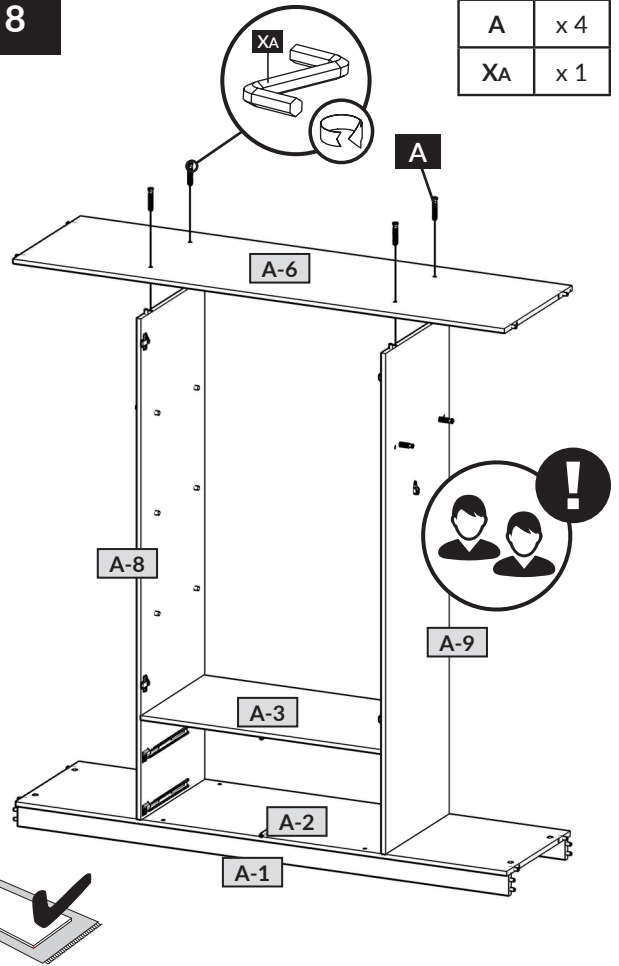

**A/9**

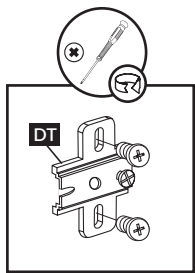

DT	x 6
E	x 4
G2	x 4
U	x 12
V7	x 2

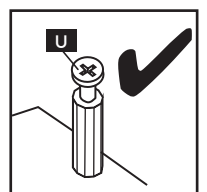
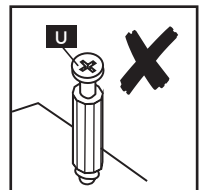
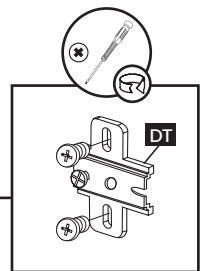
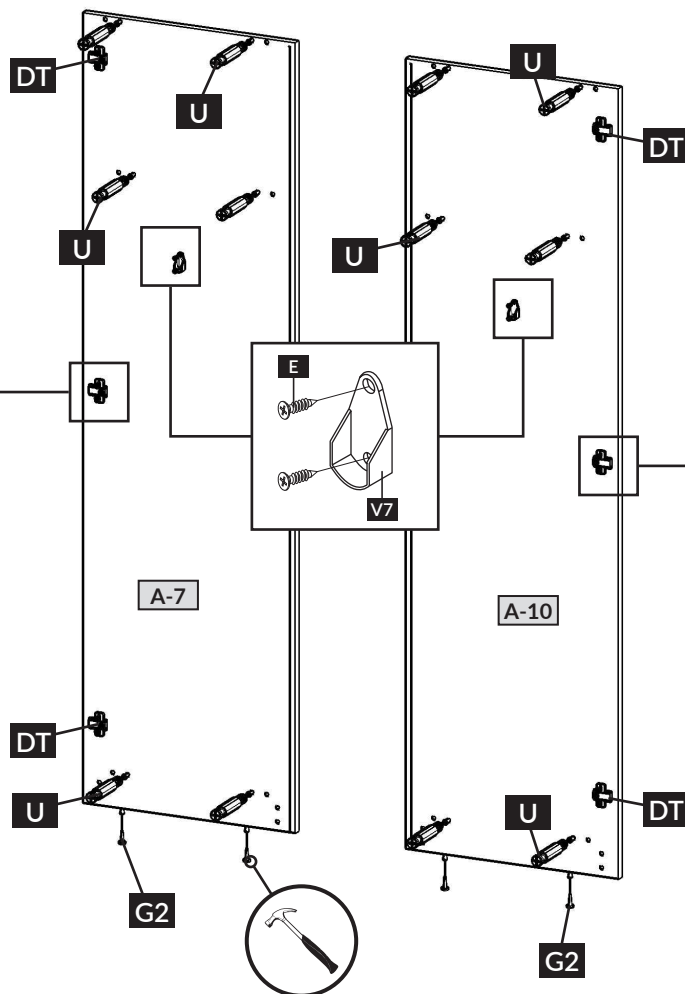

A / 10

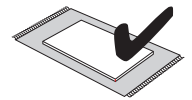
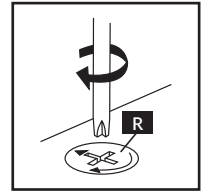
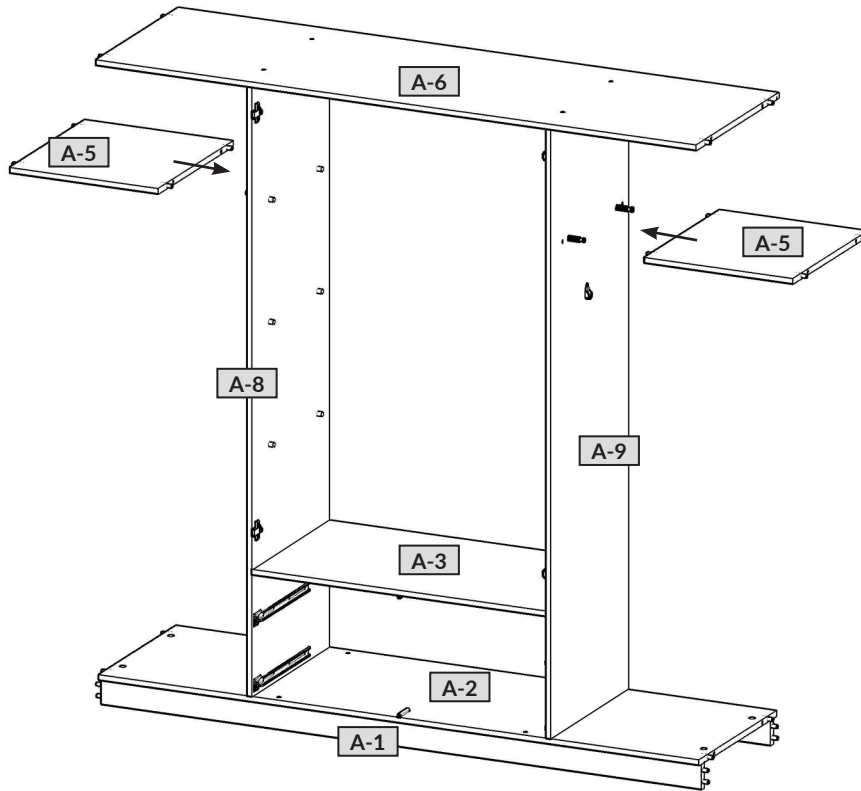

A / 11

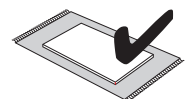
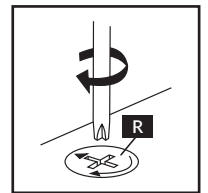
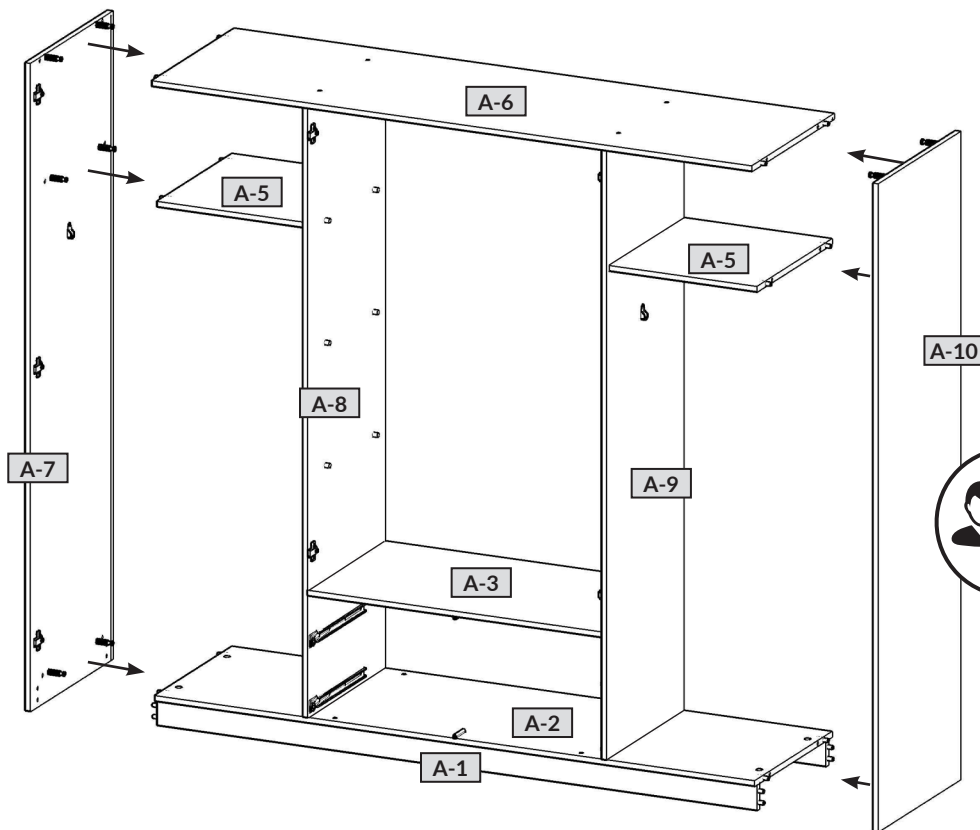

# A / 12

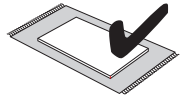

ZR	x 8
----	-----

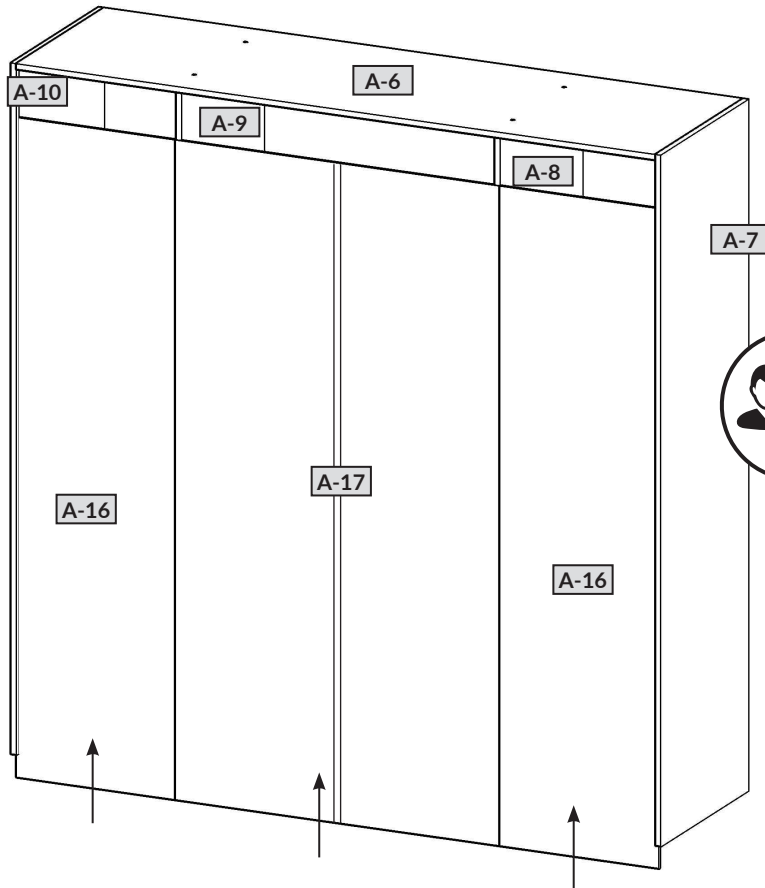
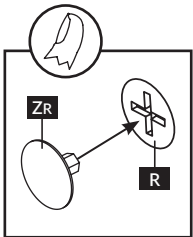

# A / 13

E2	x 44
H1	x 12
Q2	x 20

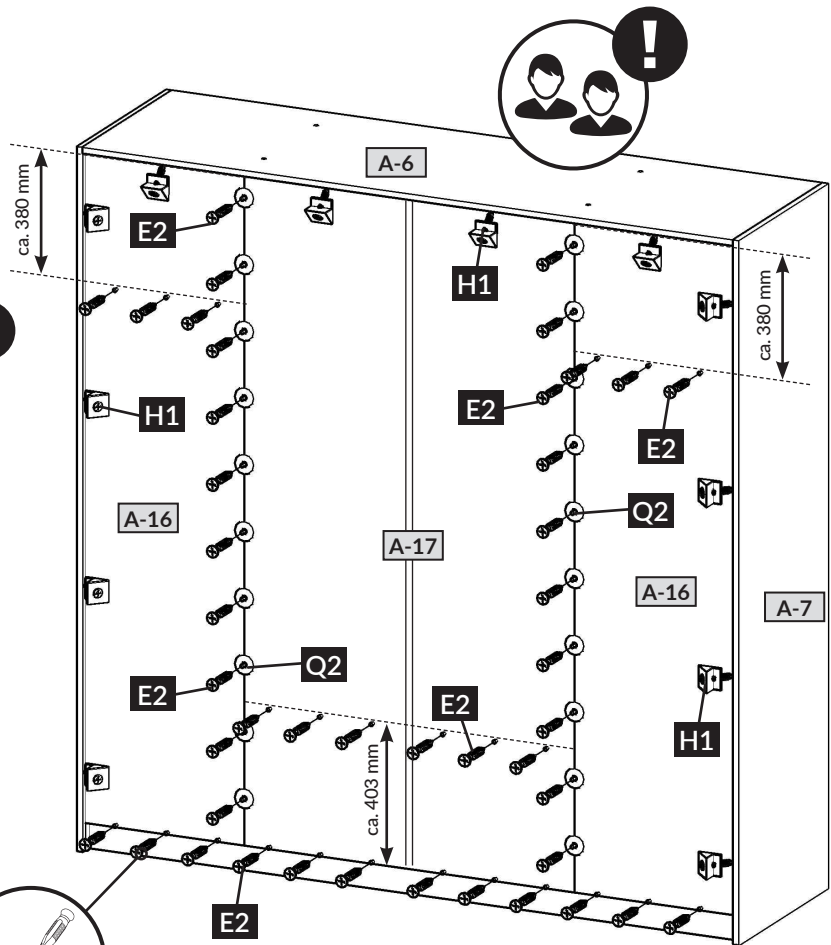
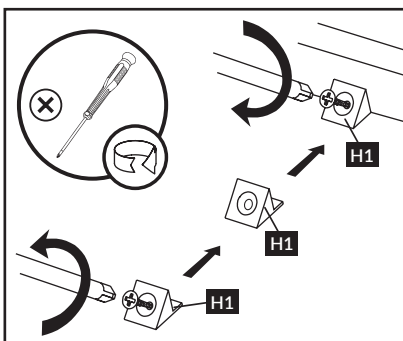
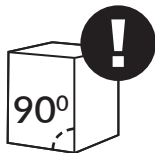
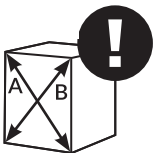
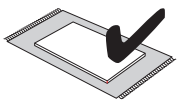



# A / 14

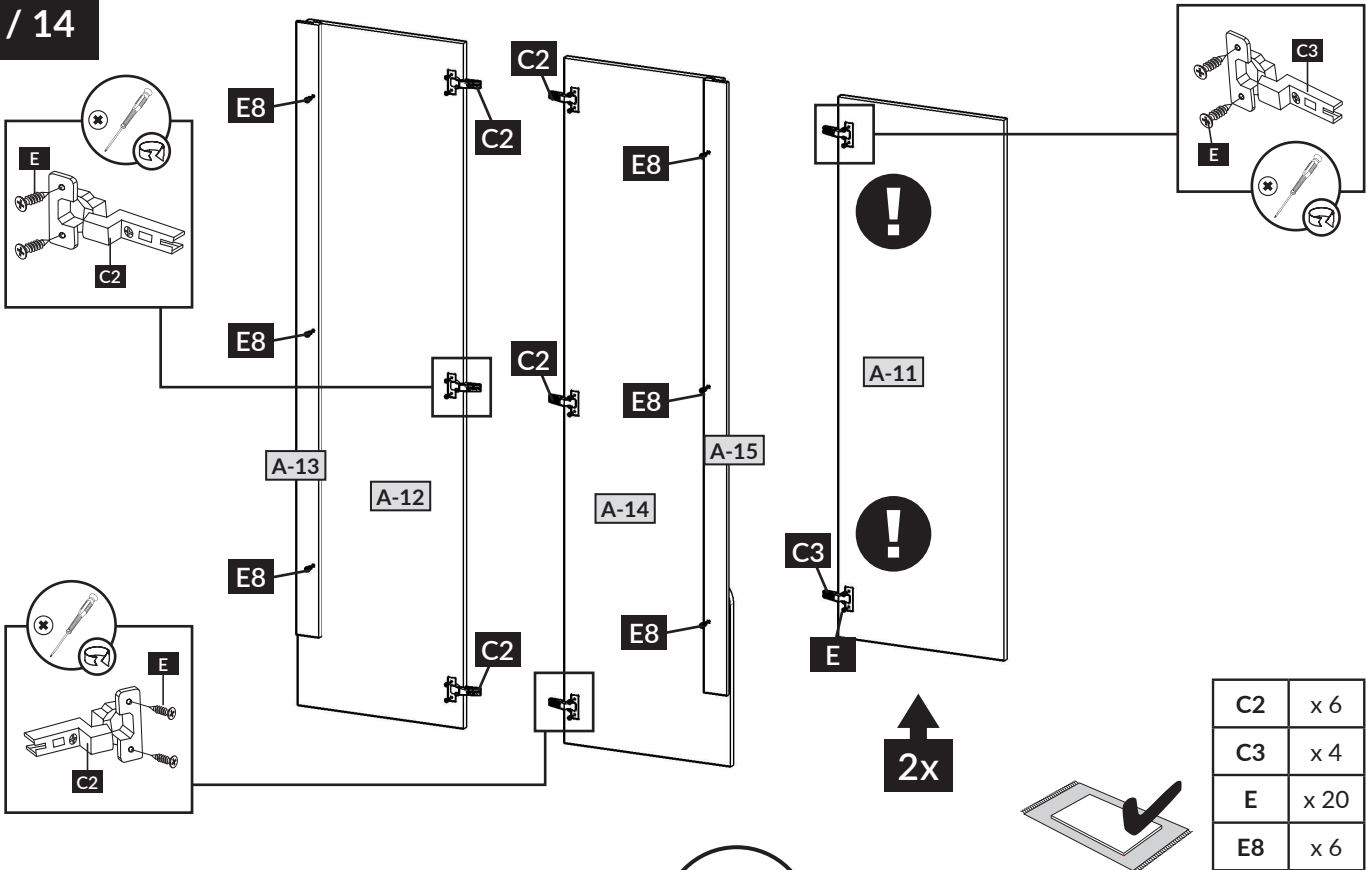

# A / 15

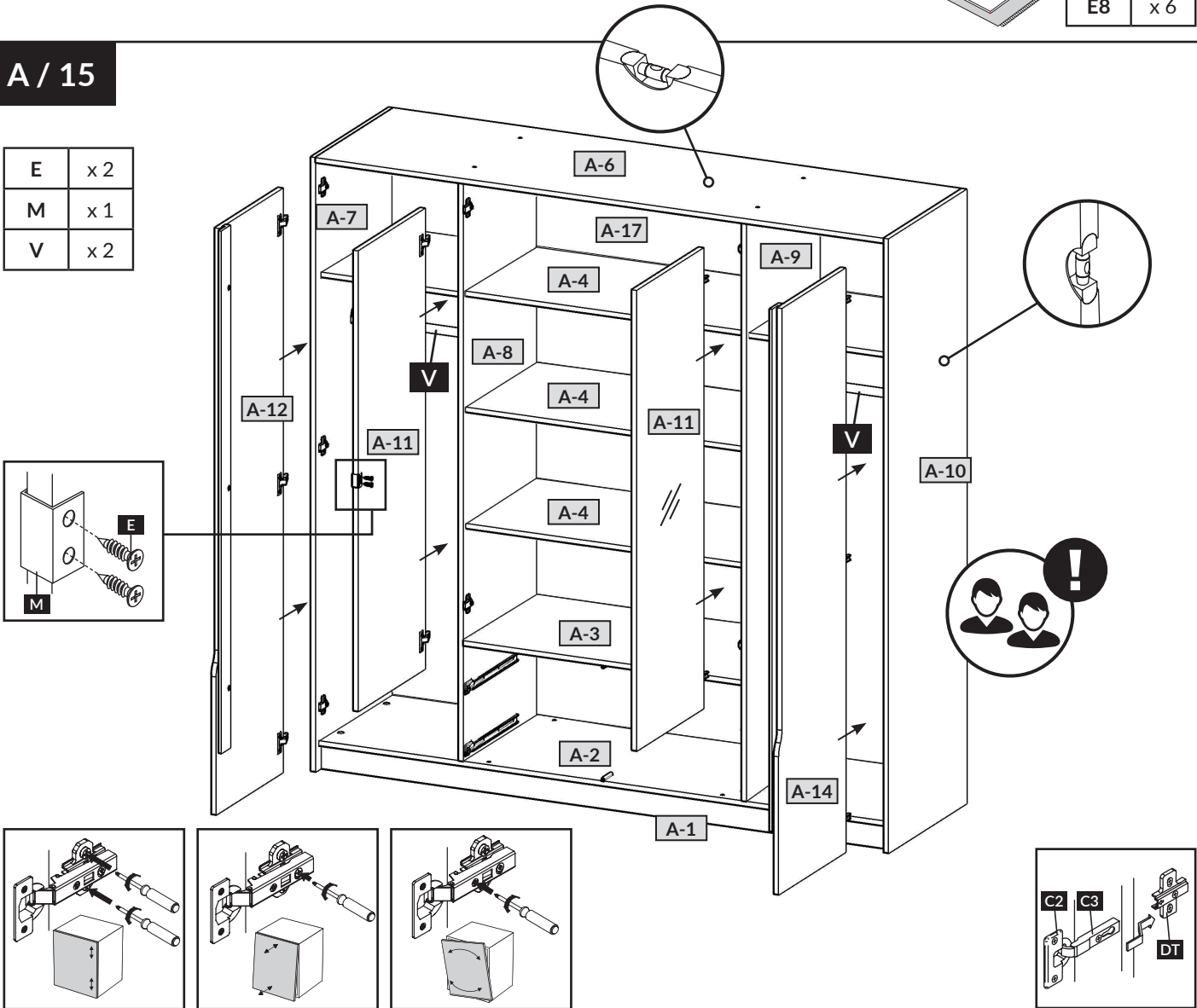

**A / 16**

**B** x 16

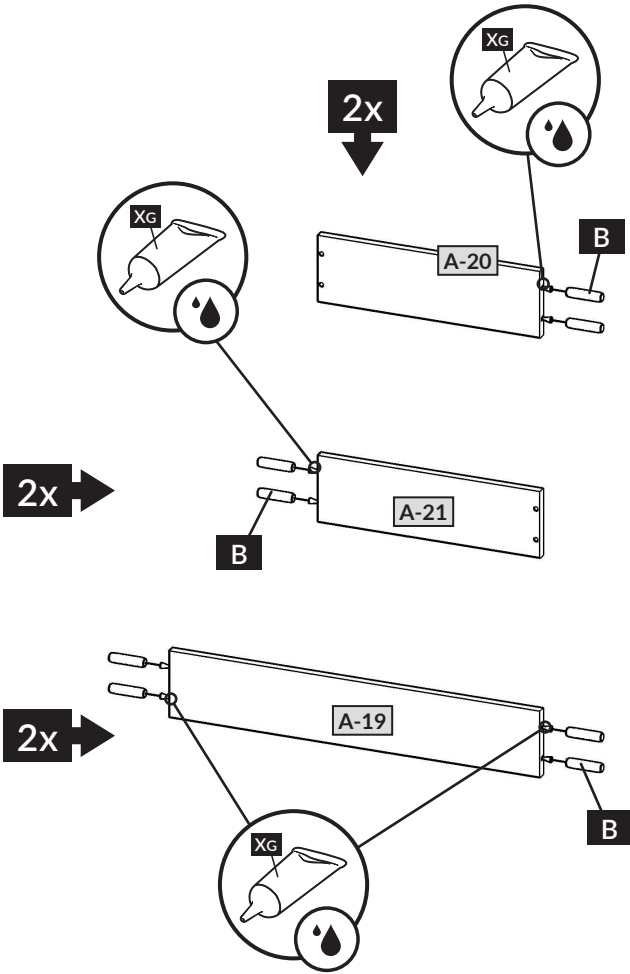
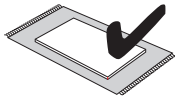

**A / 17**

**XG** x 1

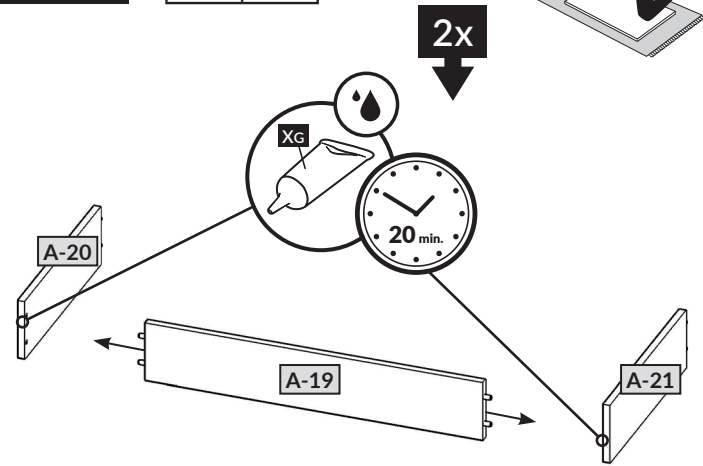
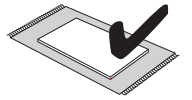

**A / 18**

**XG** x 1

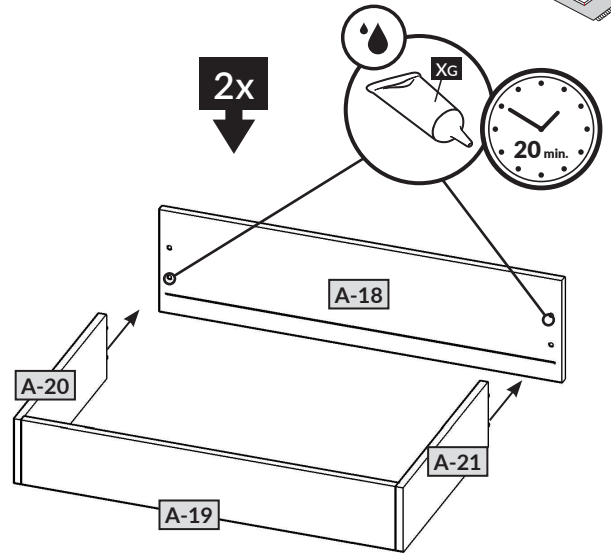
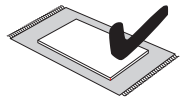

**A / 19**

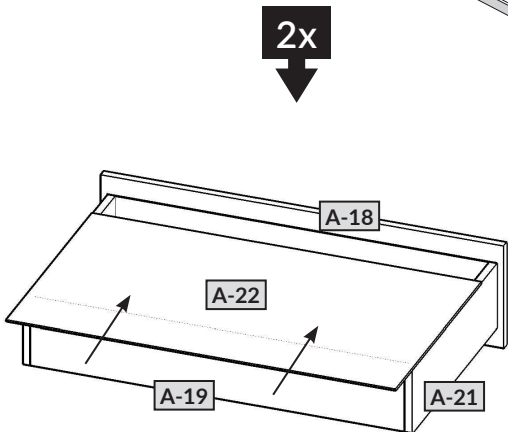
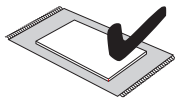

**A / 20**

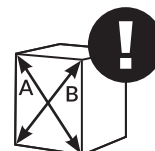
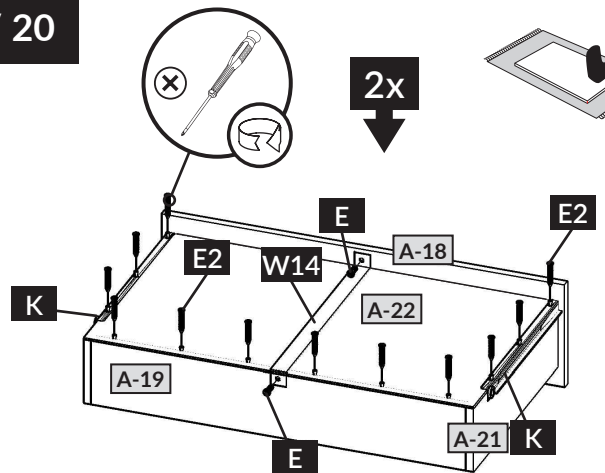
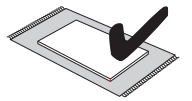

<b>E</b>	x 4
<b>E2</b>	x 24
<b>K</b>	x 2
<b>W14</b>	x 2









